

YGG.3B.26.CLAD82Z

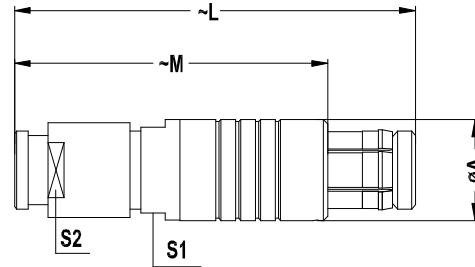

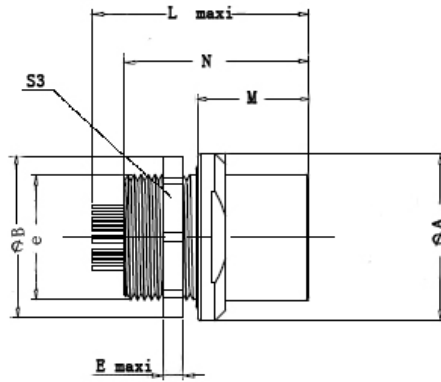

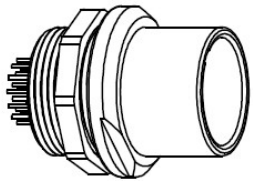

Reference		Dimension				
Model	Series	L	M	A	S1	S2
YGG	3B	65.0	50.0	18	16	15

SLG.3B.26.CLL



Reference		Dimension								
Model	Series	L	M	N	A	B	E	e	S1	S3
SLG	3B	32.0	16.0	26.5	24.0	18.0	3.0	M18x1.0	-	-

Insulator

Series	Contact Code	Contact Dia(mm)	Contact Resistance(mΩ)	Working Current(A)	Working Volt		Testing Volt		Pins	Male Insulator	Female Insulator
					V/DC	V/AC	V/DC	V/AC			
											
3B	26	0.7	7.0	5.0	825	475	1300	950	26	